





### TECHNICAL DATA

		300-26	350-23
<b>Product Code</b>	p/n	G2PROJET-26	G2PROJET-23
<b>TECHNICAL DATA</b>			
Working Pressure	psi / bar	4350 / 300	5075 / 350
Flow Rate	l/min	26	23
Max Inlet Temperature	°c / °f	60 / 140	60 / 140
Class (AS/NZS 4233.1:2013)	class	B (7800 BAR/LITRES)	B (8050 BAR/LITRES)
<b>MOTOR FEATURES</b>			
Engine	type	HONDATM GX690 (4 stroke, air cooled)	HONDATM GX690 (4 stroke, air cooled)
Power	hp / cc	24 / 690	24 / 690
Starting System	type	El. Key start	El. Key start
Hour Metre	y / n	Y	Y
Fuel supply	type	Unleaded	Unleaded
Fuel Capacity	litres	25	25
Low Oil Shutdown	y / n	Y	Y
<b>HYDRAULIC FEATURES</b>			
Pump / Head / Pistons / Valves	type / material	JW® Italian Triplex Plunger/Brass (Nickle Plated)/Ceramic	JW® Italian Triplex Plunger/Brass (Nickle Plated)/Ceramic
Motor Pump Coupling	type	Gearbox Drive	Gearbox Drive
Pump Speed	rpm	1450	1450
Unloader Valve	type / material	Independent	Independent
Safety Valve	y / n	Y	Y
Orifice / Nozzle	size	065	05
<b>OTHER FEATURES</b>			
Adjustable Pressure	y / n	Y	Y
Hose Reel Provision	y / n	Y (3 positions)	Y (3 positions)
Frame Structure	type	Galvanised & powder coated modular skid with heavy gauge stainless steel cover	Galvanised & powder coated modular skid with heavy gauge stainless steel cover
Onboard Accessory Storage	y / n	Y	Y
<b>WARRANTY(S)</b>			
Engine Warranty	years	3 	3 
Pump Warranty	years	3 	3 

\*Coverage against defects in material and workmanship (refer to Jetwave's and component partners T&Cs).

### STANDARD EQUIPMENT



### OPTIONAL EQUIPMENT

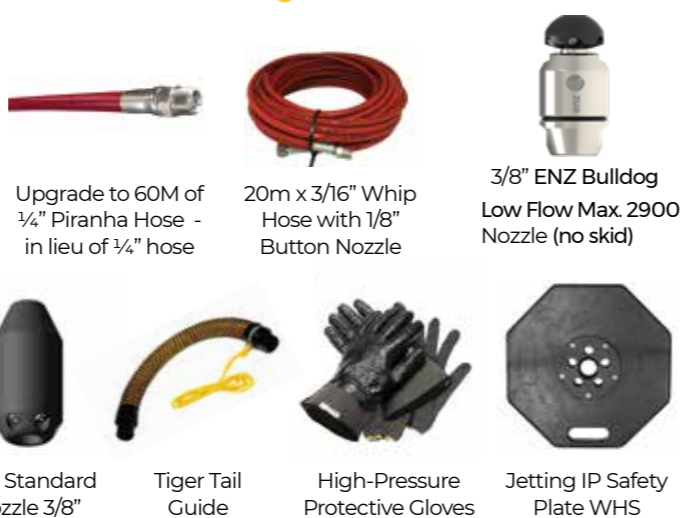

## PROJET WATER JETTING SYSTEM

The Projet G2 range revolutionises the typical petrol driven water jetting packages. Australian engineered and assembled; its innovation provides plumbers with a compact powerful, safe and easy to use unit that encompasses all new stainless steel cover protection & multi-configurable design.



POWERED by **HONDA**

### INNOVATION

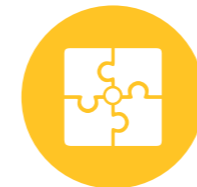

**MULTI CONFIGURATION**



**CENTRALISED CONTROL**



**COVER PROTECTION**



**ANTI-VIBRATION PROTECTION SYSTEM™**



**SKID CONFIGURATION**

**SEAMLESSLY SKID MOUNTED  
YOUR WAY 8 SOLUTIONS  
1 PRODUCT.**

## MULTI CONFIGURATION

New versatility suitable for almost any mounting arrangement you can imagine due to its industry leading compact modular design and configuration options. Because the Projet G2 takes up less space it allows you to carry more gear and equipment so you're ready for anything.

## CENTRALISED CONTROL

Easily accessible and front facing and panel mounted controls in order to maximise effectiveness, operator friendliness efficiency and easier mounting configuration.

## COVER PROTECTION

The industrial formed stainless steel cover design provides enduring weather protection to the entire machine and importantly its critical working components protecting it from harsh outdoor weather elements.

## ANTI-VIBRATION PROTECTION SYSTEM™

The AVPS (Anti-Vibration Protection System) contributes to a quieter performance. It has a heavy duty steel motor plate to separate vibration frequency created from the power plant via high duro rubber and enforced steel dampeners.

## SKID CONFIGURATION

The skid design ensures the unit remains well planted at all times, preventing run-aways. For transportation the forklift pockets provide safety and convenience.

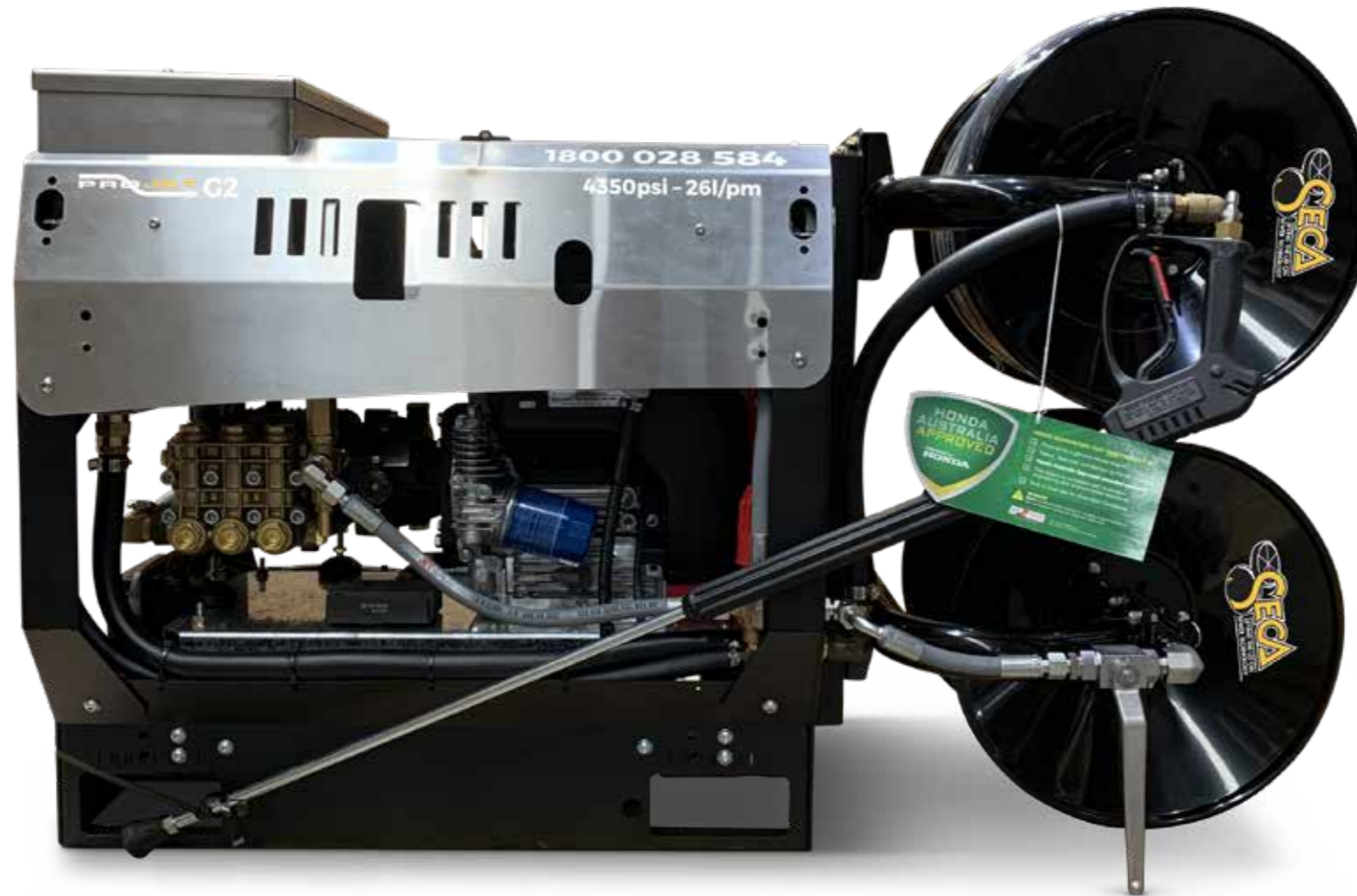

\*Unit shown with optional front double stack reels

## TRAILER MOUNT

Double hose reels & large tool box & 300L tank



## UTE MOUNT



Standard

Double Stack

Front Double Stack (on unit)

## VAN MOUNT

Double Stacked with Drip Tray

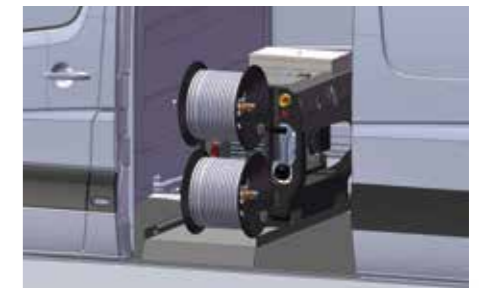

# SEAMLESSLY SKID MOUNTED YOUR WAY 8 SOLUTIONS, 1 PRODUCT.

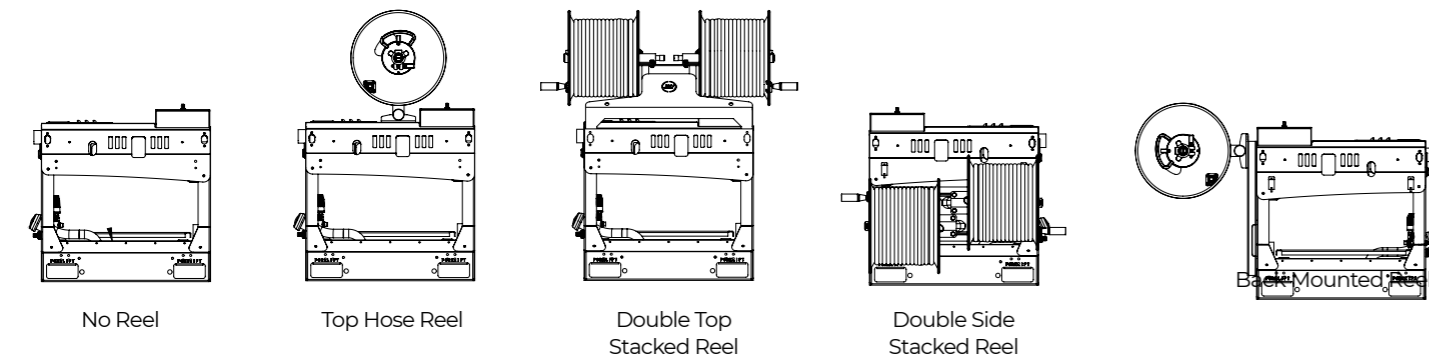

No Reel

Top Hose Reel

Double Top Stacked Reel

Double Side Stacked Reel

Back Mounted Reel

## MACHINE UPGRADES

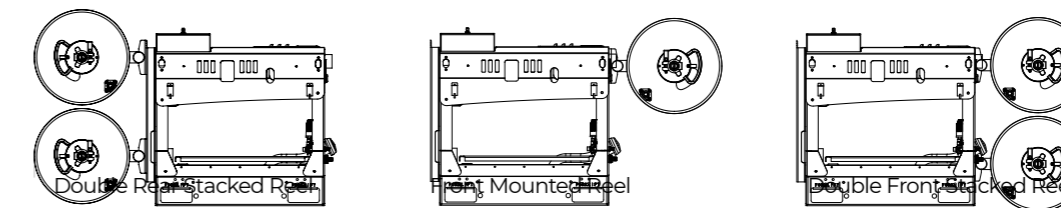

Double Rear Stacked Reel

Front Mounted Reel

Double Front Stacked Reel



Van Mounted Drip Tray

Trolley Kit